



## TABLE OF CONTENTS

<b>TABLE OF CONTENTS</b> .....	<b>1</b>
<b>IMPORTANT SAFETY NOTICE</b> .....	<b>2</b>
<b>1.0 General Information</b> .....	<b>3</b>
1.1 System Components .....	3
1.2 Specifications .....	3
1.2.1 Torque Ranges.....	3
1.2.2 Electrical Specifications.....	3
1.2.3 Environmental Specifications.....	3
<b>2.0 Power Requirements</b> .....	<b>4</b>
2.1 AC Mains Power.....	4
2.2 Earth Grounding Safety .....	4
2.3 Ground Fault Current Interrupt (GFCI).....	4
2.4 Extension Cords.....	4
<b>3.0 Tool System</b> .....	<b>4</b>
3.1 Tool Handle .....	4
3.1.1 Trigger Lock.....	5
3.2 Screen Navigation.....	5
<b>4.0 LCD Display Interface</b> .....	<b>6</b>
4.1 Main Screen .....	6
4.2 User Access Levels.....	6
4.2.1 Unlocking Access Levels.....	7
4.2.2 Returning to the Locked Level.....	8
4.3 Functions .....	9
4.3.1 Select a Preset .....	9
4.3.2 Hard Joint Mode.....	9
4.3.3 View Tool Information .....	10
4.3.4 View Last Result.....	11
4.3.5 View Life Cycles .....	11
4.3.6 View Maintenance Cycles .....	12
4.3.7 Change the Target Torque.....	12
4.3.8 Save a Preset.....	13
4.3.9 Change the Torque Units .....	14
4.3.10 Set the Clock.....	15
4.3.11 Clear Maintenance Cycles.....	15
4.3.12 Tool Calibration .....	16
4.3.13 Default Calibration.....	18
<b>5.0 General Operating Instructions</b> .....	<b>19</b>
5.1 Reaction Arm .....	19
5.1.1 Installing the Reaction Arm .....	19
5.1.2 Reaction Arm Height .....	20
5.1.3 Reaction Arm Foot.....	21
5.1.4 Reaction Points .....	21
5.2 Torque Operation .....	22
<b>6.0 Errors</b> .....	<b>23</b>
<b>7.0 CONTACT US</b> .....	<b>24</b>



## IMPORTANT SAFETY NOTICE

**RAD TOOLS ARE SAFE AND RELIABLE. NOT FOLLOWING PRECUATIONS AND INSTRUCTIONS OUTLINED HERE CAN RESULT IN INJURY TO THE TOOL, OPERATOR AND FELLOW WORKERS.**

**NEW WORLD TECHNOLOGIES INCORPRATED IS NOT RESPONSIBLE FOR ANY SUCH INJURY.**

The intended use of the Digital V-RAD Tool System is for commercial and industrial bolting applications.

Do not operate the Digital V-RAD Tool System before reading and understanding this user manual and noting the Safety Notices displayed on the Digital V-RAD Tool System and throughout this manual.

Only qualified personnel with training in the safe operation of torque tooling and the Digital V-RAD Tool System should attempt the installation, operation and diagnosis of the Digital V-RAD Tool System.

The Digital V-RAD Tool System is connected to high voltage power and consists of external rotating parts. Improper training and use can cause serious or fatal injury.

Do not disassemble or attempt to repair the Digital V-RAD Tool System; doing so will void warranty. If breakdown, malfunction or damage occurs and the Digital V-RAD Tool System fails to operate correctly, contact New World Technologies Inc. Technical Support (refer to Section 7.0 – Contact Us).

The Digital V-RAD Tool System should only be used if environmental storage and operation specifications have been met. Refer to Section 1.2.3 – Environmental Specifications.

Electrical Shock can cause serious or fatal injury. Do not apply power to the Digital V-RAD Tool System without verifying the Earth Ground.

Ensure all AC Mains Power wiring to the Digital V-RAD comply with all National and Local Electrical Codes. Improper wiring may result in unsafe conditions for equipment and personnel.

Do not operate the Digital V-RAD Tool System in explosive atmospheres, including, but not limited to, the presence of flammable liquids, gases or dust. The Digital V-RAD Tool System creates sparks which could ignite these substances.

Do not expose the Digital V-RAD Tool System to wet conditions. Water in the Digital V-RAD Tool System will cause damage to the tool and increase the risk of electric shock.

After long durations of use, the Digital V-RAD Tool System will become hot. It is recommended to use the tool in short intervals and allow for cooling between uses to prevent injury to the operator or damage to the Digital V-RAD Tool System.

While operating the Digital V-RAD Tool System, always wear safety goggles and keep all body parts clear of moving parts and the reaction arm contact point.

Never exceed the Maximum Torque of the Digital V-RAD Tool System. Failure to comply will result in void warranty.

The V-RAD Tool System has been calibrated by a qualified Calibration Technician; calibration must be done by a qualified Calibration Technician. Improper calibration can cause damage to the tool and joint.



## 1.0 General Information

### 1.1 System Components

The Digital V-RAD Tool System is shipped from New World Technologies Inc. in a case with the following parts:

- Digital V-RAD Tool (Figure 1.1-1)
- Standard Reaction Arm and Snap Ring (Figure 1.1-2)
- Calibration Certificate
- User Manual



Figure 1.1-1: Digital V-RAD Tool



Figure 1.1-2: Standard Reaction Arm

**Note:** Some distributors may ship additional parts along with the Digital V-RAD Tool System.

### 1.2 Specifications

#### 1.2.1 Torque Ranges

The following table outlines the torque ranges, in Foot-Pounds and Newton-Meters, of each Digital V-RAD Tool System:

Imperial		Metric		
DV-RAD 1000	400-1000 FtLb	or	DV-RAD 1350	550-1350 Nm
DV-RAD 1500	600-1500 FtLb	or	DV-RAD 2000	800-2000 Nm
DV-RAD 2500	1000-2500 FtLb	or	DV-RAD 3390	1350-3400 Nm

Table 1.2.1: Torque Ranges

#### 1.2.2 Electrical Specifications

Ensure that all Electrical Specifications are followed when utilizing the Digital V-RAD Tool System.

	Units	120V Model	230V Model
<b>Nominal Input Voltage</b>	VAC	120	230
Minimum Input Voltage	VAC	108	185
Maximum Input Voltage	VAC	133	260
<b>Nominal Tool Voltage</b>	VDC	170	325
Minimum Tool Voltage	VDC	153	262
Maximum Tool Voltage	VDC	188	368
<b>Nominal Input Current</b>	ARMS	8.1	4.2
<b>Nominal Input Power</b>	W	900	900

Table 1.2.2: Electrical Specifications

#### 1.2.3 Environmental Specifications

##### CAUTION!

Only operate the Digital V-RAD Tool System if the following environmental storage and operation specifications have been met.

Temperature Ranges	°C	°F
Operating Temperature	0 – 40	32 – 104
Storage Temperature	-25 – 70	-13 – 158
Humidity	10% to 90% non-condensing	
Shock	10G according to DIN IEC 68-2-6/29	
Vibration	1G, 10-150Hz according to DIN IEC 68-2-6/29	
Required Operating Conditions	<ul style="list-style-type: none"> <li>- Non explosive atmosphere</li> <li>- Dry location</li> </ul>	



Table 1.2.3: Environmental Specifications

## 2.0 Power Requirements

The installer of this equipment is responsible for complying with National Electrical Code (NEC) or equivalent Federal and Local Guidelines and Application Codes that govern protection, earth grounding, disconnects and other current protection for electrical equipment for use in outdoor or indoor applications.

The following sections outline the Digital V-RAD power requirements.

### 2.1 AC Mains Power

#### **DANGER!**

Electrical Shock can cause serious or fatal injury. Do not apply power to the Digital V-RAD Tool System without verifying the Earth Ground. If using a power plug adapter, ensure the Earth Ground pin is present and firmly connected.

#### **WARNING!**

Ensure all AC Mains wiring to the Digital V-RAD Tool System comply with all National and Local Electrical Codes. Improper wiring may result in unsafe conditions for equipment and personnel.

The Digital V-RAD Controller requires model specific single phase 120VAC or 230VAC.

The single phase line must be electrically symmetrical with respect to earth ground. The branch circuit must be a dedicated 15A to ensure proper tool operation and to avoid circuit loading and nuisance trips.

**Note:** The Digital V-RAD is internally fused for self-protection. Contact New World Technologies Inc. Technical Support for assistance if a blown fuse is suspected.

### 2.2 Earth Grounding Safety

#### **Important!**

Earth grounding is the primary electrical shock protection and is mandatory!

The Digital V-RAD is assembled with a dedicated earth ground connection to the Tool Handle. It is the operator's responsibility to adhere and follow, at minimum, an Assured Grounding Program and all National and Local Electrical Codes.

### 2.3 Ground Fault Current Interrupt (GFCI)

GFCI's are secondary protection devices which protect against electric shock in the event of a ground wiring fault.

Standard Class A-GFCI typically have a leakage current trip range of 4mA – 6mA and may be used if required.

**Note:** National and Local Electrical Codes may require use of GFCI. Check National and Local Electrical Code for compliance.

### 2.4 Extension Cords

Extension cord quality and condition is important to ensure personal safety and Digital V-RAD performance. Check National and Local Electrical Codes for compliance.

For extension cords under 30ft, 12AWG is recommended. For extension cords over 30ft, 10AWG is recommended.

Generally 100ft is the maximum recommended length for any extension cord, although some installations demand longer cords. Longer extension cords will reduce the voltage and speed of the Digital V-RAD Tool System and may cause nuisance trips at higher torque demands.

## 3.0 Tool System

The following sections give a visual and functional description of the Tool Handle and Navigation Keypad.

### 3.1 Tool Handle

The Digital V-RAD (Figure 3.1-1) is trigger activated with a Forward/Reverse Switch and a LCD Display.

1. On/Off Trigger – tool activation



2. Forward/Reverse Switch – controls direction of rotation
3. LCD Display – status display with access to menus and controls



Figure 3.1-1: Digital V-RAD

### 3.1.1 Trigger Lock

The Trigger Lock is useful while transporting or storing the Digital V-RAD. The Trigger Lock disables the use of the On/Off Trigger, therefore disabling the tool. It is suggested that while the Digital V-RAD is not in use, the Trigger Lock should be enabled.

To enable the Trigger Lock:

1. Slide the Forward/Reverse Switch to the Centre Position (neither fully to the right nor fully to the left).

**Note:** The On/Off Trigger cannot be depressed.

To disable the Trigger Lock:

1. Slide the Forward/Reverse Switch to the Forward Position or the Reverse Position.

**Note:** The On/Off Trigger can be depressed.

### 3.2 Screen Navigation

The keypad located below the LCD Display consists of three buttons used to navigate the Digital V-RAD Interface. The "Up Arrow" button is used to increment through values and navigate through columns. The "Down Arrow" button is used to decrement through values and navigate through rows. The "Centre" button is used to select options and enter the Main Menu.





Figure 3.2-1: LCD Display Keypad

**Note:** When pressing the navigation buttons, press and hold for about a second. This will ensure that the button press was properly registered.

## 4.0 LCD Display Interface

### CAUTION!

LCD Displays are susceptible to mechanical shock and any force exerted on the module may result in damage.

### CAUTION!

LCD Displays can be damaged by moisture or water and high temperatures. Avoid such conditions when storing and gently wipe clean or let dry before usage.

The Digital V-RAD Controller includes an LCD Display. This simple LCD Display interface has many functions, including Presets, Torque Settings and Calibration. The following sections describe these functions, as well as how to enable and/or use them.

Refer to Section 3.2 – Screen Navigation to understand the use of the buttons referred to in this section.

### 4.1 Main Screen

The Main Screen is used as the central control point of the Digital V-RAD Tool System. The Target Torque, Torque Units, Digital V-RAD Model and Tool Status are displayed on the Main Screen. Figure 4.1-1 shows the main screen and indicates important aspects.



Figure 4.1-1: Main Screen

### 4.2 User Access Levels

Access to the functions on the LCD Display has been constricted to four Access Levels: the Locked Level, the Basic Level, the Intermediate Level and the Advanced Level. Access to the last three levels requires a password. Each level has a different password and access to different functions. Table 4.2-1 outlines the functions accessible to each level.

Functions	Level			
	Locked	Basic	Intermediate	Advanced
Selecting a Preset	YES	YES	YES	YES
Hard Joint Mode	YES	YES	YES	YES
View Tool Information	YES	YES	YES	YES
View Last Result	YES	YES	YES	YES
View Life Cycles	YES	YES	YES	YES
View Maintenance Cycles	YES	YES	YES	YES
Change Target Torque	NO	YES	YES	YES
Save a Preset	NO	YES	YES	YES
Change Torque Units	NO	YES	YES	YES
Set the Clock	NO	NO	NO	YES
Clear Maintenance Cycles	NO	NO	NO	YES
Tool Calibration	NO	NO	NO	YES
Default Calibration	NO	NO	NO	YES



Table 4.2-1: User Access Levels and Functions

**Note:** The Digital V-RAD Tool System is shipped from factory in the Basic Level. After configuration, it is recommended that the tool be locked for normal bolting operations to avoid inadvertent changes to tool settings and calibration.

### 4.2.1 Unlocking Access Levels

To unlock an Access Level:

1. Press the "Centre" button.  
**Result:** The Main Menu screen will be displayed (Figure 4.2.1-1).
2. Press the "Down Arrow" button to highlight the "Unlock" option.
3. Press the "Centre" button.  
**Result:** The Password Input screen will be displayed (Figure 4.2.1-2).



Figure 4.2.1-1: Main Menu Screen

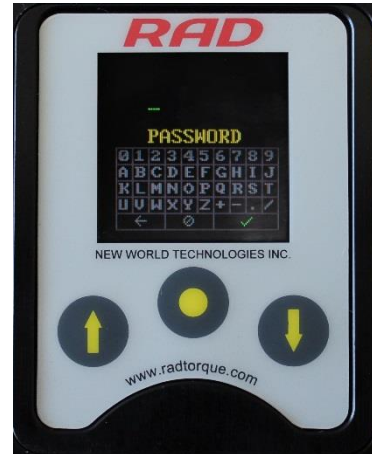

Figure 4.2.1-2: Password Input Screen

4. Use the navigation keypad to enter the desired password.  
**Note:** Use the "Up Arrow" button to move horizontally (↔) across the Password Keyboard. Use the "Down Arrow" button to move vertically (↑) on the Password Keyboard. Use the "Centre" button to select the highlighted character.
5. Select the "Check Mark" key (✓) on the Password Keyboard to enter the password.  
**Note:** Select the "Back Arrow" key (←) to delete the previous character. Select the "Cancel" key (∅) to return to the Main Menu screen without entering a password.  
**Result:** The Main screen will be displayed and the Digital V-RAD is now unlocked to the desired Access Level (Figure 4.2.1-3).



Figure 4.2.1-3: Main Screen in the Basic, Intermediate or Advanced Level  
**Note:** The Lock Icon is not visible.

Access Level	Passcode
Basic	37232



Intermediate	Contact your RAD Distributor
Advanced	Contact your RAD Distributor

Table 4.2.1-1: Access Levels and Passwords

### 4.2.2 Returning to the Locked Level

To return to the Locked Access Level:

1. Press the "Centre" button.  
**Result:** The Main Menu screen will be displayed (Figure 4.2.2-1).
2. Press the "Down Arrow" button to highlight the "Lock" option.
3. Press the "Centre" button.  
**Result:** The Password Input screen will be displayed (Figure 4.2.2-2).



Figure 4.2.2-1: Main Menu Screen

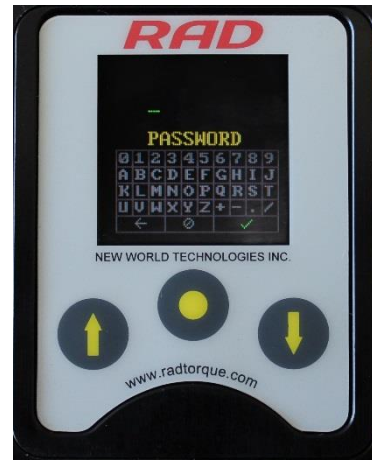

Figure 4.2.2-2: Password Input Screen

4. Use the navigation keypad to enter the Basic Level Password.  
**Note:** Use the "Up Arrow" button to move horizontally (←→) across the Password Keyboard. Use the "Down Arrow" button to move vertically (↑↓) on the Password Keyboard. Use the "Centre" button to select the highlighted character.
5. Select the "Check Mark" key (✓) on the Password Keyboard to enter the password.  
**Note:** Select the "Back Arrow" key (←) to delete the previous character. Select the "Cancel" key (∅) to return to the Main Menu screen without entering a password.  
**Result:** The Main screen will be displayed and the Digital V-RAD will be in the Locked Access Level (Figure 4.2.2-3).



Figure 4.2.2-3: Main Screen in Locked Level

**Note:** The Lock Icon is visible.





## 4.3 Functions

The following sections describe the functions available on the Digital V-RAD Display Interface. Refer to Section 4.2 – User Access Levels for more information on the accessibility of these functions.

**Note:** Menus will look different depending on the access level. The figures in this section are from the Advanced Access Level.

### 4.3.1 Select a Preset

A Preset is a pre-defined Target Torque value. They allow the operator to quickly and efficiently change the Target Torque.

To select a Preset:

1. Press the "Centre" button.  
**Result:** The Main Menu screen will be displayed (Figure 4.3.1-1).
2. Press the "Centre" button.  
**Result:** The highlight will move to the list of Presets on the right side of the screen (Figure 4.3.1-1).
3. Use the "Up Arrow" button and the "Down Arrow" button to highlight the desired Preset.
4. Press the "Centre" button to select the Preset.  
**Result:** The LCD Display will return to the Main screen. The Target Torque will be the Preset Torque and the Preset number will be displayed at the top of the screen (Figure 4.3.1-3).

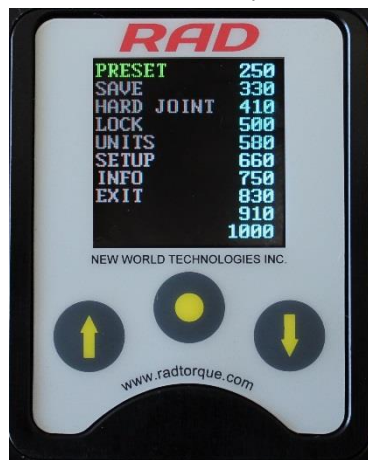

Figure 4.3.1-1: Main Menu Screen



Figure 4.3.1-2: Presets Menu Screen



Figure 4.3.1-3: Main Screen

### 4.3.2 Hard Joint Mode

#### CAUTION!

Damage to the Digital V-RAD and the joint may occur if the Joint Rate is less than 10° and Hard Joint Mode is not enabled.

The Digital V-RAD is calibrated for a Joint Rate greater than 10°. The Hard Joint Mode allows the Digital V-RAD to operate on a joint with a Joint Rate of less than 10°.

To enable/disable Hard Joint Mode:

1. Press the "Centre" button.  
**Result:** The Main Menu screen will be displayed (Figure 4.3.2-1).
2. Use the "Up Arrow" button and the "Down Arrow" button to highlight the "Hard Joint" option.
3. Press the "Centre" button to select the "Hard Joint" option.  
**Result:** The LCD Display will return to the Main screen with Hard Joint displayed (Figure 4.3.2-2).

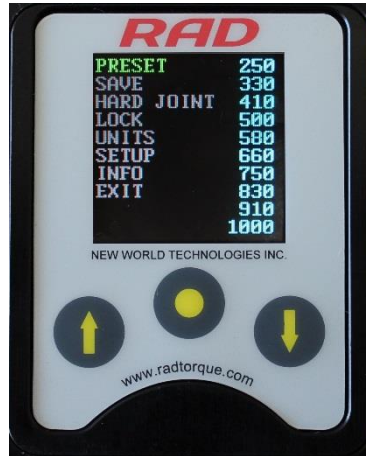

Figure 4.3.2-1: Main Menu Screen



Figure 4.3.2-2: Main Screen – Hard Joint Mode

### 4.3.3 View Tool Information

This function allows the operator to view the Digital V-RAD information including:

- Date and Time
- Software Version
- Digital V-RAD Model
- Serial Number
- Current Units
- Voltage
- Minimum Torque
- Maximum Torque

To view the Tool Information:

1. Press the "Centre" button.  
**Result:** The Main Menu screen will be displayed (Figure 4.3.3-1).
2. Use the "Up Arrow" button and the "Down Arrow" button to highlight the "Info" option.
3. Press the "Centre" button to select the "Info" option.  
**Result:** The Info Menu screen will be displayed (Figure 4.3.3-2). The "Tool Info" option will already be highlighted.
4. Press the "Centre" button to select the "Tool Info" option.  
**Result:** The Tool Information screen will be displayed (Figure 4.3.3-3).

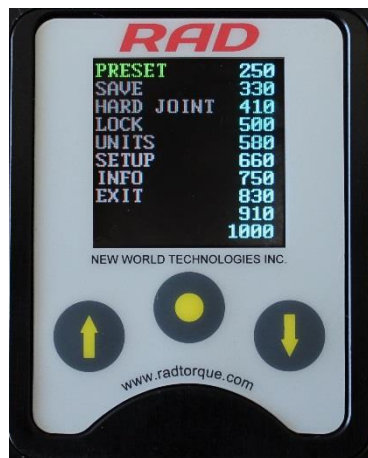

Figure 4.3.3-1: Main Menu Screen

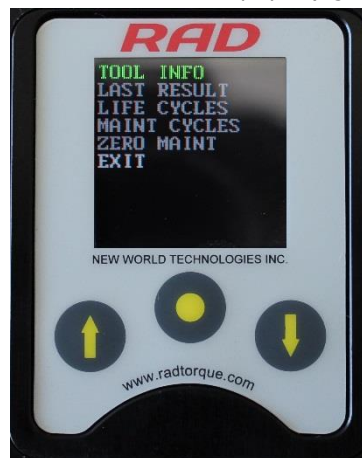

Figure 4.3.3-2: Info Menu Screen



Figure 4.3.3-3: Tool Info Screen



### 4.3.4 View Last Result

This function allows the operator to view the result of the last Torque Cycle.

To view the Last Result:

1. Press the "Centre" button.  
**Result:** The Main Menu screen will be displayed (Figure 4.3.4-1).
2. Use the "Up Arrow" button and the "Down Arrow" button to highlight the "Info" option.
3. Press the "Centre" button to select the "Info" option.  
**Result:** The Info Menu screen will be displayed (Figure 4.3.4-2).
4. Use the "Up Arrow" button and the "Down Arrow" button to highlight the "Last Result" option.
5. Press the "Centre" button to select the "Last Result" option.  
**Result:** The Last Result screen will be displayed (Figure 4.3.4-3).

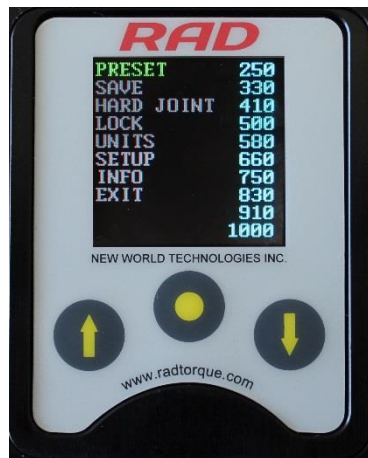

Figure 4.3.4-1: Main Menu Screen

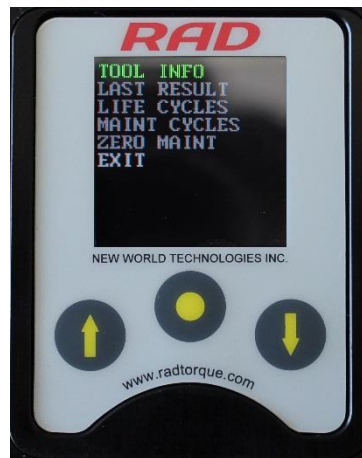

Figure 4.3.4-2: Info Menu Screen

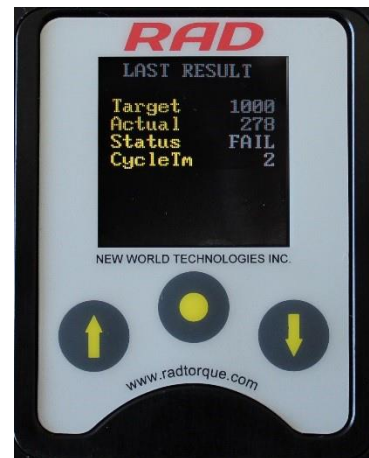

Figure 4.3.4-3: Example of Last Result Screen

### 4.3.5 View Life Cycles

This function allows the operator to view the statistics of all the Cycles conducted over the life of the tool.

To view the Life Cycles:

1. Press the "Centre" button.  
**Result:** The Main Menu screen will be displayed (Figure 4.3.5-1).
2. Use the "Up Arrow" button and the "Down Arrow" button to highlight the "Info" option.
3. Press the "Centre" button to select the "Info" option.  
**Result:** The Info Menu screen will be displayed (Figure 4.3.5-2).
4. Use the "Up Arrow" button and the "Down Arrow" button to highlight the "Life Cycles" option.
5. Press the "Centre" button to select the "Life Cycles" option.  
**Result:** The Life Cycles screen will be displayed (Figure 4.3.5-3).

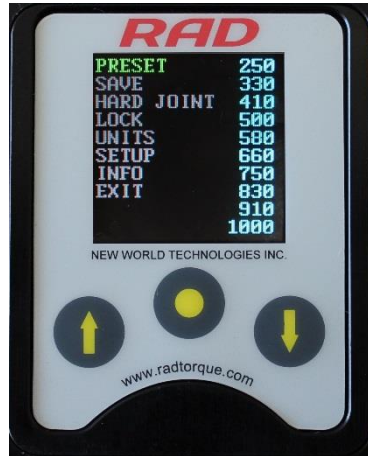

Figure 4.3.5-1: Main Menu Screen

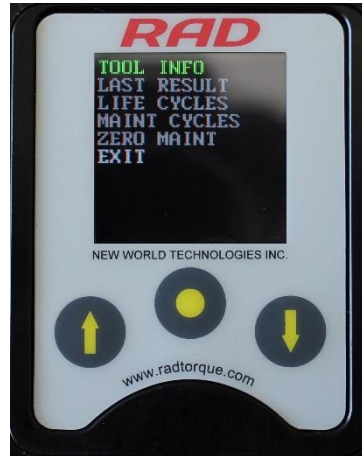

Figure 4.3.5-2: Info Menu Screen

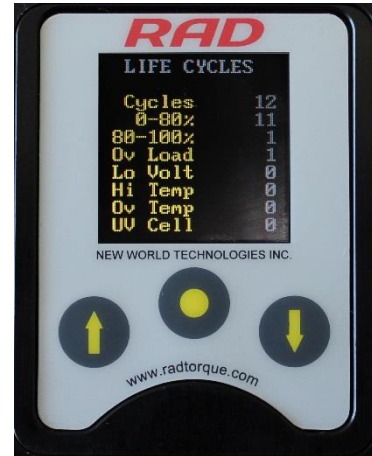

Figure 4.3.5-3: Example of Life Cycles Screen

### 4.3.6 View Maintenance Cycles

This function allows the operator to view the statistics of all the Cycles conducted since the tool's last maintenance.

To view Maintenance Cycles:

1. Press the "Centre" button.  
**Result:** The Main Menu screen will be displayed (Figure 4.3.6-1).
2. Use the "Up Arrow" button and the "Down Arrow" button to highlight the "Info" option.
3. Press the "Centre" button to select the "Info" option.  
**Result:** The Info Menu screen will be displayed (Figure 4.3.6-2).
4. Use the "Up Arrow" button and the "Down Arrow" button to highlight the "Maint Cycles" option.
5. Press the "Centre" button to select the "Maint Cycles" option.  
**Result:** The Maintenance Cycles screen will be displayed (Figure 4.3.6-3).



Figure 4.3.6-1: Main Menu Screen



Figure 4.3.6-2: Info Menu Screen



Figure 4.3.6-3: Example of Maintenance Cycles Screen

### 4.3.7 Change the Target Torque

This function allows the operator to change the Target Torque. The Target Torque is the torque value at which the Digital V-RAD will stop the Torque Cycle and the cycle will be considered a pass. For more information on the Target Torque and Torque Cycle, refer to Section 4.2 – Torque Operation.

**Note:** Refer to Section 1.2.1 – Torque Ranges for more information.



To change the Target Torque:

1. Use the "Up Arrow" button to increase the Target Torque and use the "Down Arrow" button to decrease the Target Torque.

**Result:** The Target Torque displayed on the Main screen will change. Once the desired Target Torque is displayed, the Digital V-RAD is ready for a Torque Cycle.

#### 4.3.8 Save a Preset

This function allows the operator to modify any of the ten Presets. Presets are pre-defined Target Torques. For more information on using Presets, refer to Section 4.3.1 – Select a Preset.

To save a Preset:

1. Change the Target Torque to the desired torque value (Figure 4.3.8-1). Refer to Section 4.3.7 – Change the Target Torque.

2. Press the "Centre" button.

**Result:** The Main Menu screen will be displayed (Figure 4.3.8-2).



Figure 4.3.8-1: Main Screen



Figure 4.3.8-2: Main Menu Screen

3. Use the "Up Arrow" button and the "Down Arrow" button to highlight the "Save" options.
4. Press the "Centre" button to select the "Save" option.
5. Use the "Up Arrow" button and the "Down Arrow" button to highlight the Preset to be modified (Figure 4.3.8-3).

**Note:** The Target Torque previously saved as this Preset will be overwritten by the new Target Torque.

6. Press the "Centre" button to select the Preset.

**Result:** The Target Torque is now saved as the Preset and is displayed in the Presets Menu (Figure 4.3.8-4).



Figure 4.3.8-3: Presets Menu



Figure 4.3.8-4: Presets Menu

### 4.3.9 Change the Torque Units

This function allows the operator to change the torque units to Foot-Pounds (FtLb) or Newton-Meters (Nm). When the units are changed, the Target Torque value, Preset Torque Values and Calibration Values are automatically converted to the selected units.

To change the torque units:

1. Press the "Centre" button.

**Result:** The Main Menu screen will be displayed (Figure 4.3.9-1).



Figure 4.3.9-1: Main Menu Screen

2. Use the "Up Arrow" button and the "Down Arrow" button to highlight the "Units" option.
3. Press the "Centre" button to select the "Units" option.

**Result:** If the units were FtLb, they will change to Nm. If the units were Nm, they will change to FtLb.

**Result:** The Main screen will be displayed. Confirm that the correct units are displayed (Figure 4.3.9-2).



Figure 4.3.9-2: Different Units Displayed on the Main Screen

### 4.3.10 Set the Clock

This function allows the operator to set the time and date on the Digital V-RAD.

To set the clock:

1. Press the "Centre" button.  
**Result:** The Main Menu screen will be displayed (Figure 4.3.10-1).
2. Use the "Up Arrow" button and the "Down Arrow" button to highlight the "Setup" option.
3. Press the "Centre" button to select the "Setup" option.  
**Result:** The Setup Menu screen will be displayed (Figure 4.3.10-2).
4. Use the "Up Arrow" button and the "Down Arrow" button to highlight the "Clock" option.
5. Press the "Centre" button to select the "Clock" option.  
**Result:** The Clock Setting screen will be displayed (Figure 4.3.10-3).



Figure 4.3.10-1: Main Menu Screen

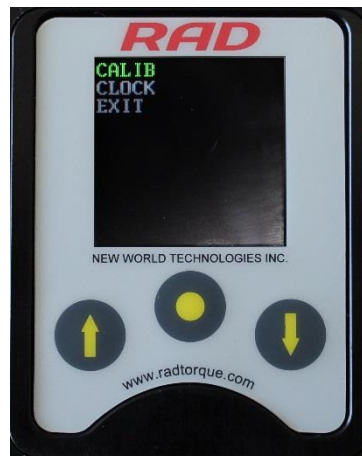

Figure 4.3.10-2: Setup Menu Screen



Figure 4.3.10-3: Clock Setting Screen

6. Use the navigation buttons and the keyboard to select and edit the time and date.  
**Note:** Use the "Up Arrow" button to move horizontally (↔) across the keyboard. Use the "Down Arrow" button to move vertically (↑) on the keyboard. Use the "Centre" button to select the highlighted character. Select the "Check Mark" key (✓) on the keyboard to enter. Select the "Back Arrow" key (←) to delete the previous character. Select the "Cancel" key (∅) to return to the Clock Setting screen without making a change.
7. Use the navigation buttons to highlight and select the "Save" option to save and exit or the "Exit" option to exit without saving.

### 4.3.11 Clear Maintenance Cycles

This function allows the operator to clear the statistics in Maintenance Cycles.



To clear Maintenance Cycles:

1. Press the "Centre" button.  
**Result:** The Main Menu screen will be displayed (Figure 4.3.11-1).
2. Use the "Up Arrow" button and the "Down Arrow" button to highlight the "Info" option.
3. Press the "Centre" button to select the "Info" option.  
**Result:** The Info Menu screen will be displayed (Figure 4.3.11-2).

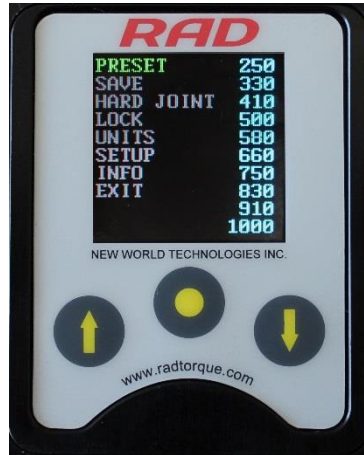

Figure 4.3.11-1: Main Menu Screen



Figure 4.3.11-2: Info Menu Screen

4. Use the "Up Arrow" button and the "Down Arrow" button to highlight the "Zero Maint" option.
5. Press the "Centre" button to select the "Zero Maint" option.

#### 4.3.12 Tool Calibration

##### **WARNING!**

Only qualified personnel with training in the safe operation of torque tooling and the Digital V-RAD Tool System should operate this tool.

##### **CAUTION!**

Do not calibrate at Target Torques that result in exceeding the Digital V-RAD Tool System's Torque Range. Sever tool damage will occur.

##### **CAUTION!**

Calibration should only be done by a Qualified Calibration Technician. Improper use of the calibration function will result in tool damage.

This function allows the operator to access the calibration values for the Digital V-RAD. These values should only be modified by a Qualified Calibration Technician and using a Calibration Stand.

To calibrate the Digital V-RAD:

1. Press the "Centre" button.  
**Result:** The Main Menu screen will be displayed (Figure 4.3.12-1).
2. Use the "Up Arrow" button and the "Down Arrow" button to highlight the "Setup" option.
3. Press the "Centre" button to select the "Setup" option.  
**Result:** The Setup Menu screen will be displayed (Figure 4.3.12-2).
4. Use the "Up Arrow" button and the "Down Arrow" button to highlight the "Calib" option.
5. Press the "Centre" button to select the "Calib" option.  
**Result:** The Calibration screen will be displayed (Figure 4.3.12-3).





Figure 4.3.12-1: Main Menu Screen

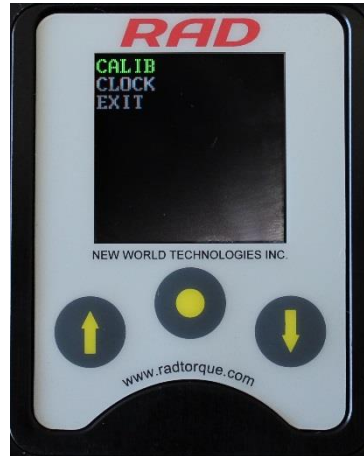

Figure 4.3.12-2: Setup Menu Screen



Figure 4.3.12-3: Calibration Screen

6. Do one Torque Cycle.
7. Press the "Centre" button to highlight the Actual Torque (Figure 4.3.12-4).

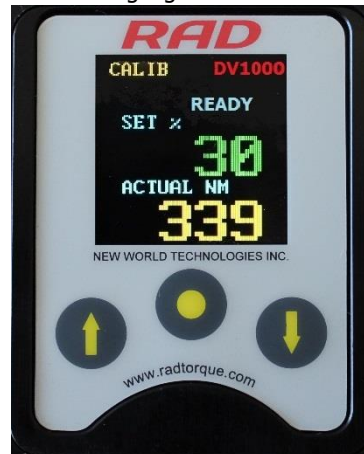

Figure 4.3.12-4: Calibration Screen – Actual Torque Highlighted

8. Use the "Up Arrow" button and the "Down Arrow" button to change the Actual Torque to the value given by the transducer on the Calibration Stand.
9. Press the "Centre" button to deselect the Actual Torque.
10. Press the "Up Arrow" button to display the next Calibration screen.
11. Repeat steps 6 – 10 until a Torque Cycle has been conducted at 30% to 100%.
12. Press and hold the "Centre" button until the Calibration Menu screen is displayed (Figure 4.3.12-5).





Figure 4.3.12-5: Calibration Menu Screen

13. Use the "Up Arrow" button and the "Down Arrow" button to highlight the "Save" option.
14. Press the "Centre" button to select the "Save" option.  
**Note:** To exit calibration without saving, select the "Exit" option.

### 4.3.13 Default Calibration

This function allows the operator to use the Default Calibration Values while calibrating the tool (refer to Section 4.3.12 – Tool Calibration). The Default Calibration Values are a reference point for efficient calibration.

**Note:** These values should never be used as Calibration Values. After enabling the Default Calibration Values, the operator must calibrate the Digital V-RAD.

To enable the Default Calibration Values:

1. Press the "Centre" button.  
**Result:** The Main Menu screen will be displayed (Figure 4.3.13-1).
2. Use the "Up Arrow" button and the "Down Arrow" button to highlight the "Setup" option.
3. Press the "Centre" button to select the "Setup" option.  
**Result:** The Setup Menu screen will be displayed (Figure 4.3.13-2).

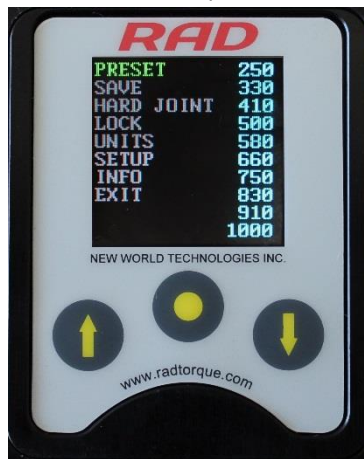

Figure 4.3.13-1: Main Menu Screen



Figure 4.3.13-2: Setup Menu Screen

4. Use the "Up Arrow" button and the "Down Arrow" button to highlight the "Calib" option.
5. Press the "Centre" button to select the "Calib" option.  
**Result:** The Calibration screen will be displayed (Figure 4.3.13-3).
6. Press and hold the "Centre" button until the Calibration Menu screen is displayed (Figure 4.3.13-4).





Figure 4.3.13-3: Calibration Screen

Figure 4.3.13-4: Calibration Menu Screen

7. Use the "Up Arrow" button and the "Down Arrow" button to highlight the "Default" option.
8. Press the "Centre" button to select the "Default" option.  
**Result:** The Default Calibration Values are saved as the Calibration Values.
9. Calibrate the Digital V-RAD. Refer to Section 4.3.12 – Tool Calibration.

## 5.0 General Operating Instructions

### WARNING!

Only qualified personnel with training in the safe operation of torque tooling and the Digital V-RAD Tool System should operate this tool.

The Digital V-RAD operates in Torque Cycles. The Torque Cycle passes when the Actual Torque reaches the Target Torque and the Cycle fails if it is interrupted and the Actual Torque does not reach the Target Torque.

This section instructs the operator in the use of the Reaction Arm needed for Digital V-RAD operation and how to conduct a Torque Cycle.

### 5.1 Reaction Arm

#### WARNING!

Always keep body parts clear of the Reaction Arm when the Digital V-RAD Tool System is in use. Serious injury could occur.

#### CAUTION!

Ensure the Reaction Arm has a solid contact point before operating the Digital V-RAD Tool System.

#### 5.1.1 Installing the Reaction Arm

Ensure the Reaction Arm and Snap Ring are installed securely to hold the Reaction Arm in place. Make sure the Reaction Arm is in contact with a solid Reaction Point before you operate the tool. Keep your body parts clear of the Reaction Arm when the tool is in operation.

When the tool is in operation the Reaction Arm rotates in the opposite direction to the Output Square Drive and must be allowed to rest squarely against a solid object or surface adjacent to the bolt to be tightened (Figure 5.1.1-1).

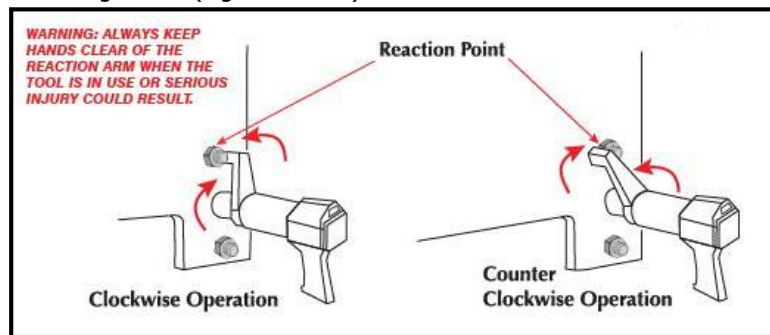

Figure 5.1.1-1 – Reaction Arm Rotation

#### CAUTION!

Keep your hand and body parts clear of the Reaction Arm and barrel when the tool is in operation.



Figure 5.1.1-2: Incorrect Placement of Hand/Body Parts During Operation

### 5.1.2 Reaction Arm Height

Ensure the height of the socket is even with the height of the Reaction Arm as seen below in Figure 5.1.2-1. The height of the socket cannot be shorter or higher than the height of the Reaction Arm as seen below in Figure 5.1.2-2.

**CORRECT:** The Reaction Arm and socket are even height.

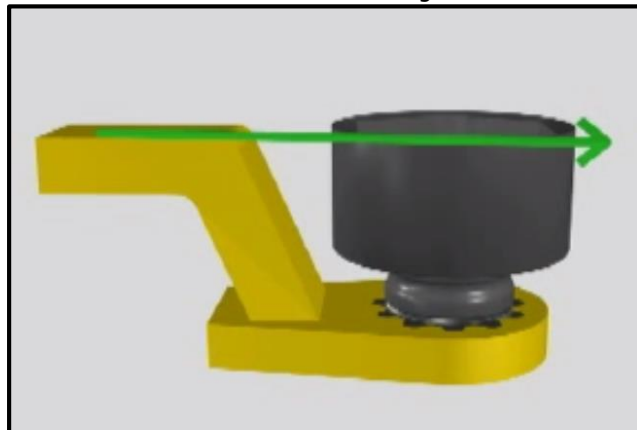

Figure 5.1.2-1: Correct Height

**INCORRECT:** The leg of the Reaction Arm is too short on the left side, and too long on the right side.

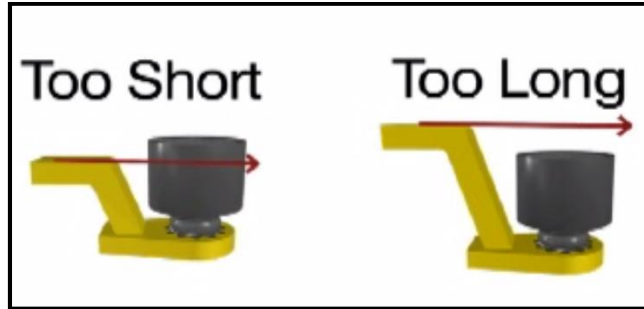

Figure 5.1.2-2: Incorrect Height

IMPROPER REACTION WILL VOID WARRANTY AND CAN CAUSE PREMATURE TOOL FAILURE.

### 5.1.3 Reaction Arm Foot

Ensure the foot of the Reaction Arm aligns with the length of the nut as seen in Figure 5.1.3-1. The length of the foot cannot be shorter or longer than the nut as seen in Figure 5.1.3-2.

**CORRECT:** The foot of the Reaction Arm aligns with the length of the nut.

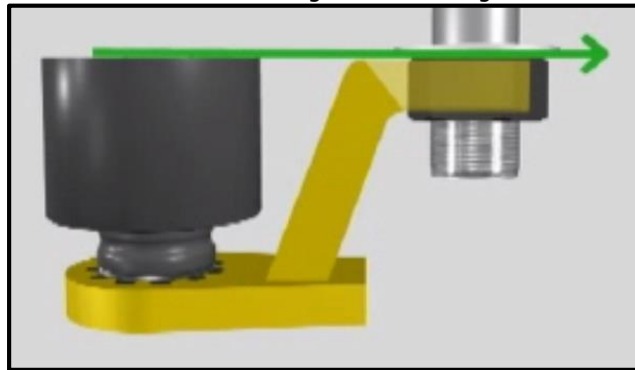

Figure 5.1.3-1: Correct Length

**INCORRECT:** The foot of the Reaction Arm is too short on the left side, and too long on the right side.

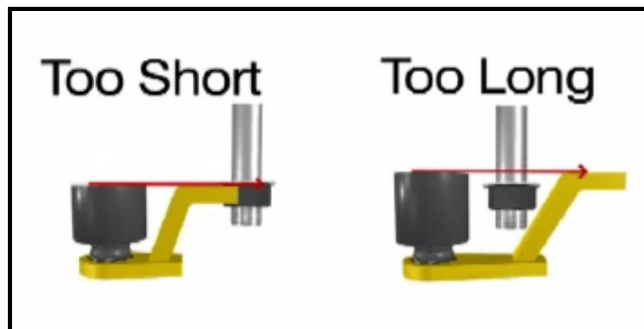

Figure 5.1.3-2: Incorrect Length

Please contact New World Technologies Inc or your local RAD Authorized Distributor for custom Reaction Arms.

### 5.1.4 Reaction Points



Ensure the Reaction Arm reacts off the middle of the foot as seen in Figure 5.1.4-1. Do not react off the heel of the reaction foot as seen in Figure 5.1.4-2.

**CORRECT:** Reaction Arm is reacting off the middle of the Reaction Arm's foot.



Figure 5.1.4-1: Correct Reaction Point

**INCORRECT:** Reaction Arm is reacting off the heel of the Reaction Arm. This can cause premature tool failure.

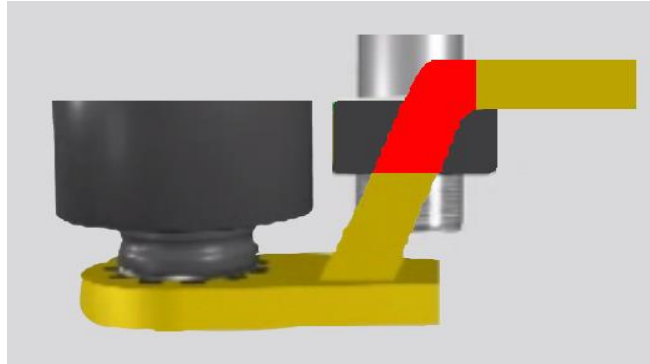

Figure 5.1.4-2: Incorrect Reaction Point

## 5.2 Torque Operation

To operate the Torque Cycle:

1. Modify the Target Torque to the desired torque. Refer to Section 4.3.7 – Change the Target Torque if the Digital V-RAD is not in the Locked Level or Section 4.3.1 – Select a Preset if it is in the Locked Level.  
**Note:** Refer to Section 1.2.1 – Torque Ranges.
2. Place the Digital V-RAD on the joint system.
3. Ensure the Forward/Reverse Switch is in the Forward Position.
4. Press and hold the On/Off Trigger.

**Note:** To stop the Torque Cycle at any time, release the On/Off Trigger. This will result in a Failed Cycle.

When the Torque Cycle is passed, the clutch mechanism will slip. Immediately release the On/Off Trigger.

### CAUTION!

Damage will occur if the clutch is allowed to slip for an extended period of time.

**Result:** The Target Torque and "Pass" (Figure 5.2-1) or "Fail" (Figure 5.2-2) will be displayed on the Main screen.



Figure 5.2-1: Passed Torque Cycle



Figure 5.2-2: Failed Torque Cycle

**Note:** The result will be displayed for ten seconds or until the Digital V-RAD is reversed or a new cycle is started.

## 6.0 Errors Important!

Disassembling or attempting repair will void warranty.

In case of an error, the following messages may appear:

STALL	– High torque at start up
HI CURR	– High current during wind-up
NO CURR	– No current during wind-up
UNDR VOLT	– Low Voltage during wind-up

If breakdown, malfunction, or damage occurs and the Digital V-RAD Tool System fails to operate correctly, contact New World Technologies Inc. Technical Support (refer to Section 7.0 – Contact Us).



## 7.0 CONTACT US

### **New World Technologies Inc.**

30580 Progressive Way  
Abbotsford, BC, V2T 6Z2  
Canada



Toll Free: 1-800-983-0044

Fax: 604-852-0269

Email: [info@radtorque.com](mailto:info@radtorque.com)

Web: [www.radtorque.com](http://www.radtorque.com)

New World Technologies Inc. Technical Support: 1-800-983-0044  
(Ext. 227)

Email: [eradsupport@radtorque.com](mailto:eradsupport@radtorque.com)

